

rtc[®]

COUPLING TECHNOLOGY

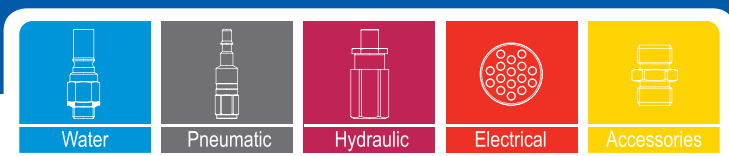

www.rtc-tec.com
www.rtc-couplings.com



EUROPEAN Type - EUROPÄISCHER Typ - AVRUPA Tip

Temperature Range - Temperaturbereich
-10°C +180°C (+14°F +356°F) FPM (V)

Max.Working Pressure - Max.Betriebsdruck
16 bar (232 PSI)

Flow size - Nennweiten

rtc 090.06 6 mm
rtc 090.09 9 mm
rtc 090.13 13 mm

Standard version - Standardversion

Brass - Messing
FPM (V) PTFE coated - Viton PTFE beschichtet
With Valve - mit Ventil
Sleeve - Nickel Plate

Option - Optionen - Seçenek

Safety lock - Sicherheitsverriegelung - Emniyetli Kapak

Safety Type



TYPE 090 **rtc**



WATER



rtc TYPE 100

Safety Type



FRENCH Type - FRANZÖSISCHER Typ - FRANSIZ Tip

Temperature Range - Temperaturbereich - Sıcaklık Aralığı
-20°C +100°C (-4°F +212°F) Nitril (N)
-10°C +180°C (+14°F +356°F) FPM (V)

Max.Working Pressure - Max. Betriebsdruck - Max. Çalışma Basıncı
10 bar (145 PSI)

Flow size - Nennweiten - Akış Çapı

rtc 100.06 6 mm
rtc 100.08 8 mm
rtc 100.12 13 mm

SAFETY Type -
Typ SICHERHEITSVERRIEGELUNG
EMNİYETLİ Tip

Flow size - Nennweiten - Akış Çapı

rtc 100.06-S* 6 mm
rtc 100.08-S* 8 mm
rtc 100.12-S* 13 mm



WATER

TYPE 101 **rtc**

Temperature Range - Temperaturbereich - Sıcaklık Aralığı

-20°C +100°C (-4°F +212°F) Nitril (N)
-10°C +180°C (+14°F +356°F) FPM (V)

Max.Working Pressure - Max. Betriebsdruck - Max. Çalışma Basıncı
16 bar (232 PSI)

Flow size - Nennweiten - Akış Çapı

rtc 101.06 6 mm
rtc 101.09 9 mm
rtc 101.10* 10 mm
rtc 101.12 12 mm
rtc 101.16 16 mm
rtc 101.20 20 mm
rtc 101.25 25 mm
rtc 101.38 38 mm



PNEUMATIC
WATER

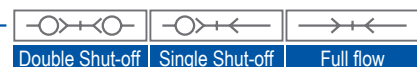

rtc TYPE 099

Safety Type



INTERNATIONAL Type - INTERNATIONAL Typ - ULUSLARARASI Tip

Temperature Range - Temperaturbereich - Sıcaklık Aralığı
-10°C +180°C (+14°F +356°F) FPM (V)

Max.Working Pressure - Max. Betriebsdruck - Max. Çalışma Basıncı
16 bar (232 PSI)

Flow size - Nennweiten - Akış Çapı

rtc 099.06	6 mm
rtc 099.09	9 mm
rtc 099.15	15 mm

Standard version - Standardversion - Standart Versiyon

Brass - Messing - Pirinç
Seals FPM (V) - FPM dichtungten - FPM Conta

Option - Optionen - Seçenek

Safety lock - Sicherheitsentriegelung - Emniyetli Kapak



Temperature Range - Temperaturbereich - Sıcaklık Aralığı
-20°C +100°C (-4°F +212°F) Nitril (N)
-10°C +180°C (+14°F +356°F) FPM (V)

Working Pressure - Betriebsdruck - Çalışma Basıncı
Brass/Messing: 50-210 bar (725 - 3045 PSI)
Stainless Steel/Edensthal: 100-300 bar (1450-4350 PSI)

Flow size - Nennweiten - Akış Çapı

rtc 070.04	4 mm
rtc 070.08	8 mm
rtc 070.10	10 mm
rtc 070.13	13 mm
rtc 070.16	16 mm
rtc 070.19	19 mm
rtc 070.32	32 mm
rtc 070.38	38 mm
rtc 070.50	50 mm

ISO 7241-1 SERIE B

TYPE 070 **rtc**



WATER
PNEUMATIC
HYDRAULIC

rtc TYPE 152

High Flow Rate



Flat Faced Non-Spill - Flachdichtende Ausführung
Düz Alınlı Damlatmasız

Temperature Range - Temperaturbereich - Sıcaklık Aralığı
-20°C +100°C (-4°F +212°F) Nitril (N)
-10°C +180°C (+14°F +356°F) FPM (V)

Max.Working Pressure - Max. Betriebsdruck - Max. Çalışma Basıncı
16-50 bar (232-750 PSI)

Flow size - Nennweiten - Akış Çapı

rtc 152.03	3 mm
rtc 152.06	6 mm
rtc 152.08	8 mm
rtc 152.10	10 mm
rtc 152.12	12 mm
rtc 152.16	16 mm
rtc 152.20	20 mm
rtc 152.25	25 mm
rtc 152.32	32 mm
rtc 152.38	38 mm
rtc 152.50	50 mm



WATER

TYPE 102 **rtc**

One Hand Connection "PUSH-PULL" Disconnection
Eine Hand Kuppeln "PUSH-PULL" Lösen
Tek El ile Kapağı "ÇEKEREK-İTEREK" Çıkarma

Temperature Range - Temperaturbereich - Sıcaklık Aralığı
-20°C +100°C (-4°F +212°F) Nitril (N)
-10°C +180°C (+14°F +356°F) FPM (V)

Max.Working Pressure - Max. Betriebsdruck - Max. Çalışma Basıncı
50 bar (725 PSI)

Flow size - Nennweiten - Akış Çapı

rtc 102.03	3 mm
rtc 102.06	6 mm
rtc 102.07	7 mm
rtc 102.09	9 mm
rtc 102.12	12 mm
rtc 102.16	16 mm
rtc 102.25	25 mm

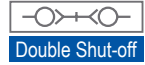

WATER 

rtc TYPE 093



Temperature Range - Temperaturbereich - Sıcaklık Aralığı
-20°C +100°C (-4°F +212°F) Nitril (N)
-10°C +180°C (+14°F +356°F) FPM (V)

Max.Working Pressure - Max. Betriebsdruck - Max. Çalışma Basıncı
20 bar (290 PSI)

Flow size - Nennweiten - Akış Çapı
rtc 093.08 8 mm



 WATER

Single & Double Shut-Off

TYPE 106 **rtc**



New Design

Temperature Range - Temperaturbereich - Sıcaklık Aralığı
-20°C +100°C (-4°F +212°F) Nitril (N)
-10°C +180°C (+14°F +356°F) FPM (V)

Max.Working Pressure - Max. Betriebsdruck - Max. Çalışma Basıncı
10 bar (145 PSI)

Flow size - Nennweiten - Akış Çapı

rtc 106.19	19 mm
rtc 106.25	25 mm
rtc 106.33	33 mm
rtc 106.42*	42 mm
rtc 106.50	50 mm
rtc 106.63*	63 mm
rtc 106.110*	110 mm



WATER 

rtc TYPE 097 & 098

Temperature Range - Temperaturbereich - Sıcaklık Aralığı
 -10°C +180°C (+14°F +356°F) FPM (V)

Max.Working Pressure - Max. Betriebsdruck - Max. Çalışma Basıncı
 100 bar (1450 PSI)

Flow size - Nennweiten - Akış Çapı
 rtc 097.08 8 mm



Double Shut-off

Leak Tight on Connection & Disconnection

Temperature Range - Temperaturbereich - Sıcaklık Aralığı
 -20°C +100°C (-4°F +212°F) Nitril (N)
 -10°C +180°C (+14°F +356°F) FPM (V)
 0°C +250°C (+32°F +482°F) FFKM (W)

Max.Working Pressure - Max. Betriebsdruck - Max. Çalışma Basıncı
 16 bar (232 PSI)

Flow size - Nennweiten - Akış Çapı
 rtc 105.09 9 mm
 rtc 105.12 12 mm
 rtc 105.16 16 mm
 rtc 105.20 20 mm
 rtc 105.25 25 mm



Temperature Range - Temperaturbereich - Sıcaklık Aralığı
 -10°C +180°C (+14°F +356°F) FPM (V)

Max.Working Pressure - Max. Betriebsdruck - Max. Çalışma Basıncı
 16 - 20 bar (232 - 290 PSI)

Flow size - Nennweiten - Akış Çapı
 rtc 098.06 6 mm
 rtc 098.08 8 mm
 rtc 098.12 12 mm

 WATER

TYPE 105 **rtc**

Double Shut-off

 WATER

rtc TYPE 108

One Hand Connection "PUSH-PULL" Disconnection
 Eine Hand Kuppeln "PUSH-PULL" Lösen
 Tek El ile Kapağı "ÇEKEREK-İTEREK" Çıkarma

Temperature Range - Temperaturbereich - Sıcaklık Aralığı
 -20°C +100°C (-4°F +212°F) Nitril (N)
 -10°C +180°C (+14°F +356°F) FPM (V)

Max.Working Pressure - Max. Betriebsdruck - Max. Çalışma Basıncı
 180 bar (2610 PSI)

Flow size - Nennweiten - Akış Çapı
 rtc 108.06 6 mm
 rtc 108.07 7 mm
 rtc 108.09 9 mm
 rtc 108.12 12 mm
 rtc 108.16 16 mm

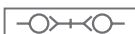

Double Shut-off

 WATER
 HYDRAULIC

NewFlow Sizes

Safety Type

TYPE 103 **rtc**

Temperature Range - Temperaturbereich - Sıcaklık Aralığı
-20°C +100°C (-4°F +212°F) Nitril (N)
-10°C +180°C (+14°F +356°F) FPM (V)

Max. Working Pressure - Max. Betriebsdruck - Max. Çalışma Basıncı

rtc 103.06*	6 mm	800 bar (11.600 PSI)
rtc 103.07*	7 mm	550 bar (8.000 PSI)
rtc 103.08	8 mm	450 bar (6.525 PSI)
rtc 103.11	11 mm	450 bar (6.525 PSI)
rtc 103.12	12 mm	400 bar (5.800 PSI)
rtc 103.15	15 mm	400 bar (5.800 PSI)
rtc 103.19	19 mm	400 bar (5.800 PSI)
rtc 103.25	25 mm	350 bar (5.075 PSI)
rtc 103.33	33 mm	350 bar (5.075 PSI)



Max. Residual Pressure for Connection Under Pressure (150 bar / only 103.07 is 400 bar)

Max. Restruck für die Verbindung unter Druck (150 bar / nur 103.07 ist 400 bar)

Max. Basınç Altında Takma Basıncı (150 bar / sadece 103.07 400 bar)

HYDRAULIC

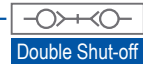

Double Shut-off

rtc TYPE 124



Temperature Range - Temperaturbereich - Sıcaklık Aralığı
-20°C +100°C (-4°F +212°F) Nitril (N)
-10°C +180°C (+14°F +356°F) FPM (V)

Max. Working Pressure - Max. Betriebsdruck - Max. Çalışma Basıncı

rtc 124.06	450 bar (6525 PSI)
rtc 124.08	450 bar (6525 PSI)
rtc 124.09	350 bar (5075 PSI)
rtc 124.12	350 bar (5075 PSI)
rtc 124.16	350 bar (5075 PSI)

Flow size - Nennweiten - Akış Çapı

rtc 124.06	6 mm
rtc 124.08	8 mm
rtc 124.09	9 mm
rtc 124.12	12 mm
rtc 124.16	16 mm

Max. Residual Pressure for Connection Under Pressure (150 bar)

Max. Restruck für die Verbindung unter Druck (150 bar)

Max. Basınç Altında Takma Basıncı (150 bar)

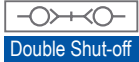

Double Shut-off

HYDRAULIC

ISO 6150 - C

TYPE 170 **rtc**

Temperature Range - Temperaturbereich - Sıcaklık Aralığı
-20°C +100°C (-4°F +212°F) Nitril (N)
-10°C +180°C (+14°F +356°F) FPM (V)

Flow size - Nennweiten - Akış Çapı

Max. Working Pressure - Max. Betriebsdruck - Max. Çalışma Basıncı

rtc 170.03	3 mm	400 bar (5800 PSI)
rtc 170.06	5.5 mm	450 bar (6525 PSI)
rtc 170.08	8 mm	400 bar (5800 PSI)
rtc 170.11	11 mm	350 bar (5100 PSI)
rtc 170.12	12 mm	350 bar (5100 PSI)
rtc 170.13	13 mm	350 bar (5100 PSI)
rtc 170.16	16 mm	320 bar (5100 PSI)
rtc 170.19	19 mm	300 bar (4350 PSI)



WATER PNEUMATIC HYDRAULIC

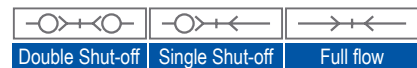

Double Shut-off Single Shut-off Full flow

rtc TYPE 072 ISO 16028

Safety Type



Temperature Range - Temperaturbereich - Sıcaklık Aralığı
-20°C +100°C (-4°F +212°F) Nitril (N)
-10°C +180°C (+14°F +356°F) FPM (V)

Working Pressure - Betriebsdruck - Çalışma Basıncı
270 - 325 bar (3925 - 4725 PSI)

Flow size - Nennweiten - Akış Çapı

rtc 072.06	6 mm
rtc 072.10	10 mm
rtc 072.12	12 mm
rtc 072.16	16 mm

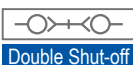

Double Shut-off

Temperature Range - Temperaturbereich - Sıcaklık Aralığı

-20°C +100°C (-4°F +212°F) Nitril (N)
-10°C +180°C (+14°F +356°F) FPM (V)

Max. Working Pressure - Max. Betriebsdruck - Max. Çalışma Basıncı
500 bar (7250 PSI)

Flow size - Nennweiten - Akış Çapı

rtc 126.08	8 mm
rtc 126.12	12 mm
rtc 126.20	20 mm
rtc 126.25	25 mm
rtc 126.33	33 mm



TYPE 126 **rtc**



HYDRAULIC

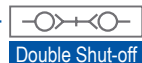

Double Shut-off

rtc TYPE 104



Temperature Range - Temperaturbereich - Sıcaklık Aralığı
-20°C +100°C (-4°F +212°F) Nitril (N)
-10°C +180°C (+14°F +356°F) FPM (V)

Working Pressure - Betriebsdruck - Çalışma Basıncı
16 - 500 bar (230 - 7250 PSI)

Flow size - Nennweiten - Akış Çapı

rtc 104.04	4 mm
rtc 104.06	6 mm
rtc 104.08	8 mm
rtc 104.10	10 mm
rtc 104.12	12 mm
rtc 104.15	15 mm
rtc 104.20	20 mm
rtc 104.25	25 mm
rtc 104.32	32 mm
rtc 104.37	37 mm
rtc 104.50	50 mm
rtc 104.75	75 mm

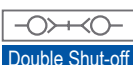

Double Shut-off

WATER
PNEUMATIC
HYDRAULIC

Compatible - Kompatibilität - Muadil
Walther LP Type

Temperature Range - Temperaturbereich - Sıcaklık Aralığı
-20°C +100°C (-4°F +212°F) Nitril (N)
-10°C +180°C (+14°F +356°F) FPM (V)

Working Pressure - Betriebsdruck - Çalışma Basıncı
30 - 100 bar (435 - 1450 PSI)

Flow size - Nennweiten - Akış Çapı

rtc 200.04	4 mm
rtc 200.06	6 mm
rtc 200.07	7 mm
rtc 200.09	9 mm
rtc 200.12	12 mm
rtc 200.19	19 mm
rtc 200.32	32 mm
rtc 200.50	50 mm

WATER
PNEUMATIC
HYDRAULIC

Low Pressure

TYPE 200 **rtc**

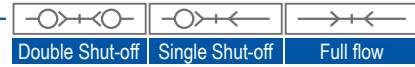

rtc TYPE 201

Medium Pressure



Compatible - Kompatibilität - Muadil
Walther MD Type

Temperature Range - Temperaturbereich - Sıcaklık Aralığı
-20°C +100°C (-4°F +212°F) Nitril (N)
-10°C +180°C (+14°F +356°F) FPM (V)

Working Pressure - Betriebsdruck - Çalışma Basıncı
100 - 250 bar (1450 - 3625 PSI)

Flow size - Nennweiten - Akış Çapı

rtc 201.06	6 mm
rtc 201.07	7 mm
rtc 201.12	12 mm
rtc 201.19	19 mm
rtc 201.25	25 mm
rtc 201.32	32 mm
rtc 201.50	50 mm



HYDRAULIC

High Pressure

TYPE 202 **rtc**

Compatible - Kompatibilität - Muadil
Walther HP Type

Temperature Range - Temperaturbereich - Sıcaklık Aralığı
-20°C +100°C (-4°F +212°F) Nitril (N)
-10°C +180°C (+14°F +356°F) FPM (V)

Working Pressure - Betriebsdruck - Çalışma Basıncı
200 - 2000 bar (2900 - 29000 PSI)

Flow size - Nennweiten - Akış Çapı

rtc 202.04	4 mm
rtc 202.06	6 mm
rtc 202.10	10 mm
rtc 202.16	16 mm
rtc 202.20	20 mm
rtc 202.32	32 mm
rtc 202.50	50 mm

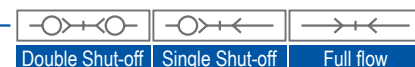

HYDRAULIC

rtc TYPE 203

High Temperature



Compatible - Kompatibilität - Muadil
Walther TE Type

Temperature Range - Temperaturbereich - Sıcaklık Aralığı
-20°C +270°C (-4°F +518°F) PTFE (T)

Working Pressure - Betriebsdruck - Çalışma Basıncı
30 - 100 bar (435 - 1450 PSI)

Flow size - Nennweiten - Akış Çapı

rtc 203.09	9 mm
rtc 203.12	12 mm
rtc 203.19	19 mm
rtc 203.32	32 mm
rtc 203.50	50 mm



Compatible - Kompatibilität - Muadil
Walther UF Type

Temperature Range - Temperaturbereich - Sıcaklık Aralığı
-20°C +100°C (-4°F +212°F) Nitril (N)
-10°C +180°C (+14°F +356°F) FPM (V)

Working Pressure - Betriebsdruck - Çalışma Basıncı
40 - 30 bar (580 - 435) for liquids
30 - 10 bar (435 - 145) for gases

Flow size - Nennweiten - Akış Çapı

rtc 204.06	6 mm
rtc 204.07	7 mm
rtc 204.12	12 mm
rtc 204.19	19 mm
rtc 204.32	32 mm

Available Codes - Verfügbaren Codes



WATER
PNEUMATIC
HYDRAULIC

Coded Un-Interchangeable serie

TYPE 204 **rtc**

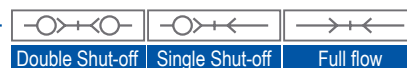

rtc TYPE 205



Compatible - Kompatibilität - Muadil
Walther CT Type

Temperature Range - Temperaturbereich - Sıcaklık Aralığı
-10°C +180°C (+14°F +356°F) FPM (V)
-20°C +150°C (-4°F +302°F) EPDM (E)
0°C +250°C (-40°F +482°F) FFKM (W)

Working Pressure - Betriebsdruck - Çalışma Basıncı
40 - 65 bar (580 - 930)

Flow size - Nennweiten - Akış Çapı

rtc type 205.05	5 mm
rtc type 205.07	7 mm
rtc type 205.09	9 mm
rtc type 205.12	12 mm
rtc type 205.19	19 mm



HYDRAULIC

Compatible - Kompatibilität - Muadil
Cejn 115

Temperature Range - Temperaturbereich - Sıcaklık Aralığı
-20°C +100°C (-4°F +212°F) Nitril (N)

Max.Working Pressure - Max. Betriebsdruck - Max. Çalışma Basıncı
1.000 bar (100 MPa - 14,503PSI)

Flow size - Nennweite
rtc 080.04 4 mm

Technical Specifications & Advantages

- Ultimate High Pressure (UHP) dripless hydraulic coupling.
- Plug and Coupler has plastic dust cap in order to increase the service life.
- Dripless connection and disconnection
- Aluminium Dust cap is also available.
- Uninterchangeable sister coupling is also available in order to avoid any mis-connection. (rtc 082.04)

Ultimate High Pressure (UHP)

TYPE 080 **rtc**

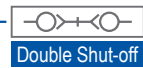

HYDRAULIC

rtc TYPE 081

Ultimate High Pressure (UHP)



Compatible - Kompatibilität - Muadil
Cejn 116

Temperature Range - Temperaturbereich - Sıcaklık Aralığı
-20°C +100°C (-4°F +212°F) Nitril (N)

Max.Working Pressure - Max. Betriebsdruck - Max. Çalışma Basıncı
1.500 bar (150 MPa - 21,755PSI)

Flow size - Nennweite
rtc 081.04 4 mm

Technical Specifications & Advantages

- Ultimate High Pressure (UHP) dripless hydraulic coupling.
- Plug and Coupler has plastic dust cap in order to increase the service life.
- Dripless connection and disconnection
- Aluminium Dust cap is also available.



HYDRAULIC

Compatible - Kompatibilität - Muadil
Cejn 125

Temperature Range - Temperaturbereich - Sıcaklık Aralığı
-20°C +100°C (-4°F +212°F) Nitril (N)

Working Pressure - Betriebsdruck
2.000 bar (200 MPa - 29,000 PSI)

Flow size - Nennweite
rtc 083.04 4 mm

Technical Specifications & Advantages

- Ultimate High Pressure (UHP) dripless hydraulic coupling.
- Plug and Coupler has plastic dust cap in order to increase the service life.
- Dripless connection and disconnection
- Aluminium Dust cap is also available.

Ultimate High Pressure (UHP)

TYPE 083 **rtc**

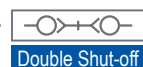

HYDRAULIC

rtc TYPE 123



Temperature Range - Temperaturbereich - Sıcaklık Aralığı

-20°C +100°C (-4°F +212°F) Nitrile (N)
 -10°C +180°C (+14°F +356°F) FPM (V)
 -20°C +150°C (-4°F +302°F) EPDM (E)
 0°C +250°C (-40°F +482°F) FFKM (W)
 -40°C +175°C (-40°F +347°F) FMQ (SN)

Max. Working Pressure - Max. Betriebsdruck - Max. Çalışma Basıncı
 260 bar (3770 PSI)

Flow size - Nennweiten - Akış Çapı

rtc 123.03 3 mm
 rtc 123.05 5 mm
 rtc 123.08 8 mm

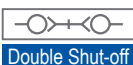

Compatible - Kompatibilität - Muadil
 Walther 11 Type

Temperature Range - Temperaturbereich - Sıcaklık Aralığı
 -20°C +325°C (-4°F +617°F) FFKM (W)

Max. Working Pressure - Max. Betriebsdruck - Max. Çalışma Basıncı
 20 bar (290 PSI)

Flow size - Nennweiten - Akış Çapı

rtc 219.12 12 mm
 rtc 219.19 19 mm

Using Area

For Hot Oil Usages - Für heiße Öl Anwendungen -
 Kızgın Yağ Kullanımı için

High Temperature



TYPE 219 **rtc**



HYDRAULIC

rtc TYPE 127



Temperature Range - Temperaturbereich - Sıcaklık Aralığı

-20°C +100°C (-4°F +212°F) Nitril (N)
 -10°C +180°C (+14°F +356°F) FPM (V)
 -50°C +150°C (-58°F +302°F) EPDM (E)

Max. Working Pressure - Max. Betriebsdruck - Max. Çalışma Basıncı
 10 bar (145 PSI)

Flow size - Nennweiten - Akış Çapı

rtc 127.37 37 mm

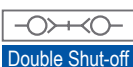

HYDRAULIC

Self Venting Safety Type
Sicherheitskupplung mit Vorentlüftungsfunktion
Hava Tahliyeli Emniyetli Tip

- The system perfectly fits to the ISO 4414, EN 983 safety standards.
- Full flow, negligible loss of pressure
- Simple operation, no force required
- Compact design

Temperature Range - Temperaturbereich - Sıcaklık Aralığı
-20°C +100°C (-4°F +212°F) Nitril (N)
-10°C +180°C (+14°F +356°F) FPM (V)

Max.Working Pressure - Max. Betriebsdruck - Max. Çalışma Basıncı
25 bar (365 PSI)
15 bar (220 PSI) Connection / Disconnection

Flow size - Nennweiten - Akış Çapı

3 mm	rtc 461
5.5 mm	rtc 460 / 461 / 462 / 466 / 467
8 mm	rtc 460 / 461 / 463 / 464 / 465 / 468 / 469
11 mm	rtc 460 / 461
19 mm	rtc 461

Connection - Anschluss - Bağlantı

1/8
1/4
3/8
1/2
3/4



PNEUMATIC

rtc TYPE 450

Sleeve Twist Coupler



Self Venting Safety Type
Sicherheitskupplung mit Vorentlüftungsfunktion
Hava Tahliyeli Emniyetli Tip

- The system perfectly fits to the ISO 4414, EN 983 safety standards.
- Model to ISO 6150-C-10 and AFNOR: C-10 NF E 49-053
- Safety feature: 2-stage disconnection

Temperature Range - Temperaturbereich - Sıcaklık Aralığı
-20°C +100°C (-4°F +212°F) Nitril (N)
-10°C +180°C (+14°F +356°F) FPM (V)

Max.Working Pressure - Max. Betriebsdruck - Max. Çalışma Basıncı
25 bar (365 PSI)
15 bar (220 PSI) Connection/Disconnection

Flow size - Nennweiten - Akış Çapı

rtc 450.03	3 mm
rtc 450.06	5.5 mm
rtc 450.08	8 mm
rtc 450.11	11 mm

Connection - Anschluss - Bağlantı

1/8
1/4
3/8
1/2



PNEUMATIC

Self Venting Safety Type
Sicherheitskupplung mit Vorentlüftungsfunktion
Hava Tahliyeli Emniyetli Tip

- The system perfectly fits to the ISO 4414, EN 983 safety standards.
- Model to ISO 6150-C-10 and AFNOR: C-10 NF E 49-053
- Safety feature: 2-stage disconnection

Temperature Range - Temperaturbereich - Sıcaklık Aralığı
-20°C +100°C (-4°F +212°F) Nitril (N)
-10°C +180°C (+14°F +356°F) FPM (V)

Max.Working Pressure - Max. Betriebsdruck - Max. Çalışma Basıncı
25 bar (365 PSI)
15 bar (220 PSI) Connection/Disconnection

Flow size - Nennweiten - Akış Çapı

rtc 451.06	5.5 mm
rtc 451.08	8 mm
rtc 451.11	11 mm

Connection - Anschluss - Bağlantı

1/4
3/8
1/2



PNEUMATIC

rtc TYPE 452

Sleeve Twist Coupler



Self Venting Safety Type
Sicherheitskupplung mit Vorentlüftungsfunktion
Hava Tahliyelii Emniyetli Tip

- The system perfectly fits to the ISO 4414, EN 983 safety standards.
- Model to ISO 6150-C-10 and AFNOR: C-10 NF E 49-053
- Safety feature: 2-stage disconnection
- Coded type (Non-Interchangeable)

Temperature Range - Temperaturbereich - Sıcaklık Aralığı

- 20°C +100°C (-4°F +212°F) Nitril (N)
- 10°C +180°C (+14°F +356°F) FPM (V)

Max.Working Pressure - Max. Betriebsdruck - Max. Çalışma Basıncı

- 25 bar (365 PSI)
- 15 bar (220 PSI) Connection/Disconnection

Flow size - Nennweiten - Akış Çapı

rtc 452.06 5.5 mm

Connection - Anschluss - Bağlantı

1/4

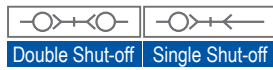

Double Shut-off Single Shut-off

Self Venting Type
Sicherheits - Schnellkupplung
Hava Tahliyelii Tip

- The system perfectly fits to the ISO 4414, EN 983 safety standards.
- Safety feature: 2-stage disconnection
- Coded type (Non-Interchangeable) is also available.

Temperature Range - Temperaturbereich - Sıcaklık Aralığı

- 20°C +100°C (-4°F +212°F) Nitril (N)
- 10°C +180°C (+14°F +356°F) FPM (V)
- 20°C +150°C (-4°F +302°F) EPDM (E)

Max.Working Pressure - Max. Betriebsdruck - Max. Çalışma Basıncı

25 bar (365 PSI)

Flow size - Nennweiten - Akış Çapı

rtc 453.11 11 mm
rtc 453.19 19 mm

Connection - Anschluss - Bağlantı

1/2
3/4

Heavy Duty Coupler

TYPE 453 **rtc**

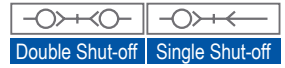
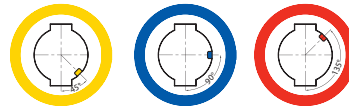

Double Shut-off Single Shut-off

WATER
PNEUMATIC

rtc TYPE 171



Self Venting Safety Type
Sicherheitskupplung mit Vorentlüftungsfunktion
Hava Tahliyelii Emniyetli Tip

- The system perfectly fits to the ISO 4414, EN 983 safety standards requirements.

Temperature Range - Temperaturbereich - Sıcaklık Aralığı

- 20°C +100°C (-4°F +212°F) Nitril (N)
- 10°C +180°C (+14°F +356°F) FPM (V)

Max.Working Pressure - Max. Betriebsdruck - Max. Çalışma Basıncı

rtc 171.06 12 bar (175 PSI)
rtc 171.08 16 bar (230 PSI)
rtc 171.11 16 bar (230 PSI)

Flow size - Nennweiten - Akış Çapı

rtc 171.06 6 mm
rtc 171.08 8 mm
rtc 171.11 11 mm

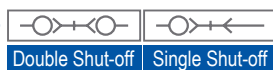

Double Shut-off Single Shut-off

PNEUMATIC

TYPE 002 **rtc**

Compatible - Kompatibilität - Muadil

rtc 463.08
rtc 025
rtc 026
Rectus 25 & 26
Cejn 320

Temperature Range - Temperaturbereich - Sıcaklık Aralığı
-20°C +100°C (-4°F +212°F) Nitril (N)

Max.Working Pressure - Max. Betriebsdruck - Max. Çalışma Basıncı
35 bar (510 PSI)

Flow size - Nennweiten - Akış Çapı
rtc 002 7.2 mm



PNEUMATIC

rtc TYPE 013



Compatible - Kompatibilität - Muadil

Nitto Kohki Hi Cupla & Hi Cupla 200
Rectus 13
Cejn 315

Temperature Range - Temperaturbereich - Sıcaklık Aralığı
-20°C +100°C (-4°F +212°F) Nitril (N)

Max.Working Pressure - Max. Betriebsdruck - Max. Çalışma Basıncı
35 bar (510 PSI)

Flow size - Nennweiten - Akış Çapı
rtc 013 7.5 mm



PNEUMATIC

TYPE 020 **rtc**

Compatible - Kompatibilität - Muadil

For Full-Flow and Single Shut-off

Rectus 20
Walther 06-003

For Double Shut-off

Rectus 20KB
Walther 06-003

Temperature Range - Temperaturbereich - Sıcaklık Aralığı
-20°C +100°C (-4°F +212°F) Nitril (N)

Max.Working Pressure - Max. Betriebsdruck - Max. Çalışma Basıncı
35 bar (510 PSI)

Flow size - Nennweiten - Akış Çapı
rtc 020 2.7 mm

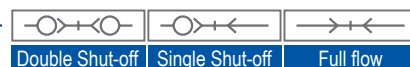

WATER PNEUMATIC

rtc TYPE 021



Compatible - Kompatibilität - Muadil
For Full-Flow and Single Shut-off
Rectus 21
Camozzi

For Double Shut-off
Rectus 21KB

Temperature Range - Temperaturbereich - Sıcaklık Aralığı
-20°C +100°C (-4°F +212°F) Nitril (N)

Max.Working Pressure - Max. Betriebsdruck - Max. Çalışma Basıncı
35 bar (510 PSI)

Flow size - Nennweiten - Akış Çapı
rtc 021 5 mm



Single Shut-off Full flow

WATER
PNEUMATIC

TYPE 022 **rtc**



Compatible - Kompatibilität - Muadil

rtc 462.06
rtc 014
AMFLO C38
ARO 210
Cejn 300
Foster 210
Parker B53
Rectus 14 & 22

Temperature Range - Temperaturbereich - Sıcaklık Aralığı
-20°C +100°C (-4°F +212°F) Nitril (N)

Max.Working Pressure - Max. Betriebsdruck - Max. Çalışma Basıncı
35 bar (510 PSI)

Flow size - Nennweiten - Akış Çapı
rtc 022 5.5 mm



Single Shut-off Full flow

PNEUMATIC

rtc TYPE 023



Compatible - Kompatibilität - Muadil

US (Industrial) MIL-C-4109 1/4
ISO 6150-B-12
rtc 460.06
Hansen 1000
Cejn 310
Foster 3003
Parker B23
Rectus 23 & 24

Temperature Range - Temperaturbereich - Sıcaklık Aralığı
-20°C +100°C (-4°F +212°F) Nitril (N)

Max.Working Pressure - Max. Betriebsdruck - Max. Çalışma Basıncı
35 bar (510 PSI)

Flow size - Nennweiten - Akış Çapı
rtc 023 5.5 mm



Single Shut-off Full flow

PNEUMATIC

TYPE 025 **rtc**

Compatible - Kompatibilität - Muadil
For Full-Flow and Single Shut-off

rtc 463.08
rtc 026
Rectus 25 & 26
Cejn 320

For Double Shut-off

Rectus 25KB & 26KB

Temperature Range - Temperaturbereich - Sıcaklık Aralığı
-20°C +100°C (-4°F +212°F) Nitril (N)

Max.Working Pressure - Max. Betriebsdruck - Max. Çalışma Basıncı
35 bar (510 PSI)

Flow size - Nennweiten - Akış Çapı
rtc 025 7.8 mm



PNEUMATIC

rtc TYPE 026



Compatible - Kompatibilität - Muadil
For Full-Flow and Single Shut-off

rtc 463.08
rtc 025
Rectus 25 & 26
Cejn 320

For Double Shut-off

Rectus 25KB & 26KB

Temperature Range - Temperaturbereich - Sıcaklık Aralığı
-20°C +100°C (-4°F +212°F) Nitril (N)

Max.Working Pressure - Max. Betriebsdruck - Max. Çalışma Basıncı
35 bar (510 PSI)

Flow size - Nennweiten - Akış Çapı
rtc 026 7.2 mm



PNEUMATIC

TYPE 027 **rtc**

Compatible - Kompatibilität - Muadil
For Full-Flow and Single Shut-off

Rectus 27
Cejn 410
Tema 1700

For Double Shut-off
Rectus 27KB

Temperature Range - Temperaturbereich - Sıcaklık Aralığı
-20°C +100°C (-4°F +212°F) Nitril (N)

Max.Working Pressure - Max. Betriebsdruck - Max. Çalışma Basıncı
35 bar (510 PSI)

Flow size - Nennweiten - Akış Çapı
rtc 027 10 mm

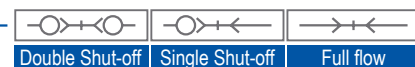

PNEUMATIC

rtc TYPE 033



Compatible - Kompatibilität - Muadil

rtc	468.08
Atlas Copco	QIC10
Rectus	33

Temperature Range - Temperaturbereich - Sıcaklık Aralığı

-20°C +100°C (-4°F +212°F) Nitril (N)

Max.Working Pressure - Max. Betriebsdruck - Max. Çalışma Basıncı
35 bar (510 PSI)

Flow size - Nennweiten - Akış Çapı

rtc 033 8.5 mm



Single Shut-off

Full flow

PNEUMATIC

TYPE 038 **rtc**



Compatible - Kompatibilität - Muadil

rtc	038.15	rtc	038.19
Rectus	38 - 38KB	Rectus	39 - 39KB
Hansen	6000	Hansen	7000

Temperature Range - Temperaturbereich - Sıcaklık Aralığı

-20°C +100°C (-4°F +212°F) Nitril (N)

Max.Working Pressure - Max. Betriebsdruck - Max. Çalışma Basıncı
35 bar (510 PSI)

Flow size - Nennweiten - Akış Çapı

rtc 038.15	15 mm
rtc 038.19	19 mm

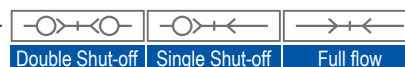

Double Shut-off

Single Shut-off

Full flow

WATER
PNEUMATIC

rtc TYPE 042



Compatible - Kompatibilität - Muadil

Parker 42

Temperature Range - Temperaturbereich - Sıcaklık Aralığı

-20°C +100°C (-4°F +212°F) Nitril (N)

-10°C +180°C (+14°F +356°F) FPM (V)

Max.Working Pressure - Max. Betriebsdruck - Max. Çalışma Basıncı
16 bar (230 PSI)

Flow size - Nennweiten - Akış Çapı

rtc 042.12 12 mm



Single Shut-off

Full flow

WATER

TYPE 043 **rtc**

Compatible - Kompatibilität - Muadil
Legris 8500L

Temperature Range - Temperaturbereich - Sıcaklık Aralığı
-20°C +100°C (-4°F +212°F) Nitril (N)
-10°C +180°C (+14°F +356°F) FPM (V)

Max.Working Pressure - Max. Betriebsdruck - Max. Çalışma Basıncı
15 bar (215 PSI) - For brass

Flow size - Nennweiten - Akış Çapı
rtc 043.12 12 mm
rtc 043.19 19 mm



WATER

rtc TYPE 044



Temperature Range - Temperaturbereich - Sıcaklık Aralığı
-20°C +100°C (-4°F +212°F) Nitril (N)
-10°C +180°C (+14°F +356°F) FPM (V)

Max.Working Pressure - Max. Betriebsdruck - Max. Çalışma Basıncı
15 bar (215 PSI) - For brass

Flow size - Nennweiten - Akış Çapı
rtc 044.11 11 mm
rtc 044.16 16 mm
rtc 044.19 19 mm



WATER

Compatible - Kompatibilität - Muadil

Parker ST
Hansen ST

Temperature Range - Temperaturbereich - Sıcaklık Aralığı
-20°C +100°C (-4°F +212°F) Nitril (N)
-10°C +180°C (+14°F +356°F) FPM (V)
-50°C +150°C (-58°F +302°F) EPDM (E)

Max.Working Pressure - Max. Betriebsdruck - Max. Çalışma Basıncı
70 - 310 bar (510 PSI) - For brass
140 - 350 bar - (2025 - 5075 PSI) For Steel
100 - 450 bar - (1450 - 6525 PSI) For Stainless-steel

Flow size - Nennweiten - Akış Çapı
rtc 045.04 4 mm
rtc 045.06 6.5 mm
rtc 045.10 9.5 mm
rtc 045.13 12.7 mm
rtc 045.19 19 mm
rtc 045.25 25 mm
rtc 045.33 33 mm
rtc 045.37 37 mm

TYPE 045 **rtc**

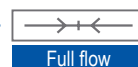

WATER
PNEUMATIC
HYDRAULIC

rtc TYPE 046



Compatible - Kompatibilität - Muadil
Snap Tite H

Temperature Range - Temperaturbereich - Sıcaklık Aralığı
-20°C +100°C (-4°F +212°F) Nitril (N)
-10°C +180°C (+14°F +356°F) FPM (V)

Max.Working Pressure - Max. Betriebsdruck - Max. Çalışma Basıncı
155 - 450 bar (400 - 2250 PSI) - Brass
100 - 450 bar (1500 - 6500 PSI) - Steel
35 - 350 bar (500 - 5000 PSI) - Stainless Steel
20 - 155 bar (300 - 2250 PSI) - Aluminium

Flow size - Nennweiten - Akış Çapı

rtc 046.06	6 mm
rtc 046.09	9 mm
rtc 046.13	13 mm
rtc 046.19	19 mm
rtc 046.25	25 mm
rtc 046.30	30 mm
rtc 046.38	38 mm
rtc 046.50	50 mm



TYPE 053 **rtc**

Compatible - Kompatibilität - Muadil
Nitto Kohki TSP

Temperature Range - Temperaturbereich - Sıcaklık Aralığı
-20°C +100°C (-4°F +212°F) Nitril (N)
-10°C +180°C (+14°F +356°F) FPM (V)

Max.Working Pressure - Max. Betriebsdruck - Max. Çalışma Basıncı
30 - 50 bar (435 - 725 PSI) - For brass
45 - 100 bar (650 - 1.450 PSI) - Stainless Steel

Flow size - Nennweiten - Akış Çapı

rtc 053.06	6 mm
rtc 053.10	10 mm
rtc 053.13	13 mm
rtc 053.19	19 mm
rtc 053.25	25 mm

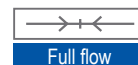

rtc TYPE 092 Knock-out Coupler / Ejector Coupler



Pneumatic Series

Advantages

- Quick and easy installation
- Return of the ejector plate is assured
- Part ejection is assured
- Coupling is obtained in any position, disconnecting is made only after the ejector plate is fully returned.
- Fast acting, up to 30 strokes per minute.
- Can be used on all injection machines equipped with hydraulic or mechanical ejection
- Set-up time can be greatly reduced.
- Reduced noise on machines with mechanical knockouts
- Especially suited for injection machines that do not have easy access to the ejector plate.

Compatible - Kompatibilität - Muadil

Max.Pull Force - Max.Zugkraft - Max. Çekme Kuvveti

rtc 092.16	1500 kg	Alba 300 Series
rtc 092.18	2400 kg	Alba 400 Series
rtc 092.19	1500 kg	Pneumatic Series
rtc 092.25	3200 kg	Alba 500 Series
rtc 092.36	6000 kg	Pneumatic Series

Vorteile

- Schnelle und einfache Installation
- Die Rückkehr der Auswurfplatte ist gewährleistet
- Teil Ausstoß ist gewährleistet
- Die Kupplung wirkt in jeder Position - Trennung erfolgt erst wenn die Auswurfplatte voll zurück gefahren ist
- Schnelle Funktionalität - bis zu 30 Hübe pro Minute
- Kann auf alle Spritzgussmaschinen ausgestattet werden mit hydraulischen oder mechanischen Auswurf
- Rüstzeit kann erheblich verkürzt werden
- Speziell für Spritzgussmaschinen mit schwer zugänglicher Auswurfplatte



TYPE BC & BCO **rtc**

Pressure Plug with Copper Washer
Verschlussstopfen mit Kupferscheibe
Bakır Pullu Kör Tıpa

PPD 10	BSP 1/8
PPD 13	BSP 1/4
PPD 17	BSP 3/8
PPD 21	BSP 1/2
PPD 26	BSP 3/4
PPD 33	BSP 1
PPD 1010	M10x1
PPD 1215	M12x1.5
PPD 1415	M14x1.5
PPD 1615	M16x1.5
PPD 2215	M22x1.5
PPD 2415	M24x1.5



Threadless Pressure Plug
Verschlussstopfen ohne Gewinde
Dişsiz Kör Tıpa

Compatible - Austauschbar - Muadil
Hasco Z 942

- 1. Material: Ms58 Brass - Messing
- 2. Material: Inner Part Stainless Steel - Edelstahl

- BC - 06
- BC - 08
- BC - 10
- BC - 11
- BC - 12
- BC - 14
- BC - 15
- BC - 16
- BC - 20



Threadless Pressure Plug with O-Ring
Verschlussstopfen mit O-Ring
O-Ringli Kör Tıpa

Compatible - Austauschbar - Muadil
EOC KN / 105

- Material: Ms58 Brass - Messing
- O-Ring: Viton
- Max. Temp: 180°C

- BCO - 06
- BCO - 07
- BCO - 08
- BCO - 8.5
- BCO - 10
- BCO - 11.5
- BCO - 12
- BCO - 14
- BCO - 15



- BCO - 16
- BCO - 20
- BCO - 22
- BCO - 25

ACCESSORIES **rtc**

rtc TYPE NOP & PPG & PPR

NOP 10/06	BSP 1/8	4x6 mm
NOP 10/08	BSP 1/8	6x8 mm
NOP 10/10	BSP 1/8	8x10 mm
NOP 13/06	BSP 1/4	4x6 mm
NOP 13/08	BSP 1/4	6x8 mm
NOP 13/10	BSP 1/4	8x10 mm
NOP 13/12	BSP 1/4	9x12 mm
NOP 17/06	BSP 3/8	4x6 mm
NOP 17/08	BSP 3/8	6x8 mm
NOP 17/10	BSP 3/8	8x10 mm
NOP 17/12	BSP 3/8	9x12 mm
NOP 21/08	BSP 1/2	6x8 mm
NOP 21/10	BSP 1/2	8x10 mm
NOP 21/12	BSP 1/2	9x12 mm



Material: Ms58 Brass - Messing
Plate: Nickel Plated - Verzinkt

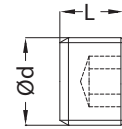

Material: Ms58 Brass - Messing

PPG 10	BSP 1/8
PPG 13	BSP 1/4
PPG 17	BSP 3/8
PPG 21	BSP 1/2
PPM 0875	M8x075
PPM 1010	M10x1
PPM 1215	M12x1.5
PPM 1415	M14x1.5
PPM 1615	M16x1.5
PPM 2015	M20x1.5

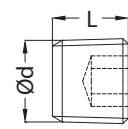

Material: Ms58 Brass - Messing

PPR 10	BSPT 1/8
PPR 13	BSPT 1/4
PPR 17	BSPT 3/8
PPR 21	BSPT 1/2
PPK 0875	M8x075
PPK 1010	M10x1
PPK 1215	M12x1.5
PPK 1415	M14x1.5
PPK 1615	M16x1.5
PPK 2015	M20x1.5

ACCESSORIES **rtc**

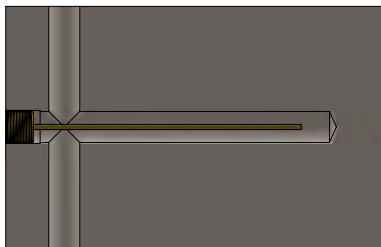

Straight Baffle (SBM)

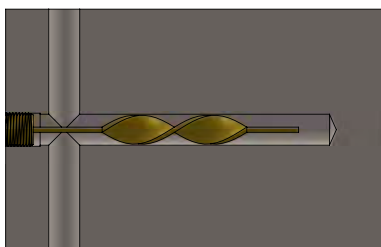

Turbo Baffle (TBM)

Baffles

TYPE SBM & TBM **rtc**



ACCESSORIES **rtc**

rtc TYPE CPE & CPW2 & SRM & SRG



Ear Hose Clamp - Ohr-Schlauchschellen
Kulaklı Hortum Kelepçesi

Material: Zinc Plated Steel

- CPE - 0709
- CPE - 0911
- CPE - 1315
- CPE - 1417
- CPE - 1518
- CPE - 1720
- CPE - 1821
- CPE - 2023



Hose Clamp - Schlauchschellen
Hortum Kelepçesi

Material:
Screw - Zinc Plated Steel
Housing - Stainless Steel
Band - Stainless Steel

- CPW2 - 0812 - 09
- CPW2 - 1016 - 09
- CPW2 - 1220 - 09
- CPW2 - 1627 - 09
- CPW2 - 2032 - 09
- CPW2 - 2540 - 09

- | | |
|--------------|-----------|
| SRM 08 x 38 | M 8x1.25 |
| SRM 08 x 60 | M 8x1.25 |
| SRM 08 x 80 | M 8x1.25 |
| SRM 08 x 100 | M 8x1.25 |
| SRM 10 x 38 | M 10x1.5 |
| SRM 10 x 60 | M 10x1.5 |
| SRM 10 x 80 | M 10x1.5 |
| SRM 10 x 100 | M 10x1.5 |
| SRM 10 x 120 | M 10x1.5 |
| SRM 10 x 150 | M 10x1.5 |
| SRM 12 x 38 | M 12x1.75 |
| SRM 12 x 60 | M 12x1.75 |
| SRM 12 x 80 | M 12x1.75 |
| SRM 12 x 100 | M 12x1.75 |
| SRM 12 x 120 | M 12x1.75 |
| SRM 12 x 150 | M 12x1.75 |
| SRM 14 x 38 | M 14x2.0 |



Extension Hose Plugs - Verlängerungsrippel - Uzatma Hortum Uç
Material: Ms58 Brass - Messing - Pirinç

- | | |
|--------------|---------|
| SRG 10 x 38 | BSP 1/8 |
| SRG 10 x 60 | BSP 1/8 |
| SRG 10 x 80 | BSP 1/8 |
| SRG 10 x 100 | BSP 1/8 |
| SRG 10 x 120 | BSP 1/8 |
| SRG 10 x 150 | BSP 1/8 |
| SRG 13 x 38 | BSP 1/4 |
| SRG 13 x 60 | BSP 1/4 |
| SRG 13 x 80 | BSP 1/4 |
| SRG 13 x 100 | BSP 1/4 |
| SRG 13 x 120 | BSP 1/4 |
| SRG 13 x 150 | BSP 1/4 |

ACCESSORIES

TYPE MMN & MFN & EBFM rtc

Male - Female Thread Adapter
Aussen - Innengewinde Adapter
Erkek - Dişi Diş Adaptörü

Material: Ms58 Brass
Messing - Pirinç



- | | | |
|---------------|---------|---------|
| MFN 13-10 | BSP 1/4 | BSP 1/8 |
| MFN 17-13 | BSP 3/8 | BSP 1/4 |
| MFN 21-17 | BSP 1/2 | BSP 3/8 |
| MFN 26-21 | BSP 3/4 | BSP 1/2 |
| MFN 1415-1010 | M14x1.5 | M10x1 |
| MFN 1815-1415 | M18x1.5 | M14x1.5 |
| MFN 2415-1615 | M24x1.5 | M16x1.5 |

(DIN 3863) Male Thread Adapter with Inner Cone
Aussengewinde Doppelnippel mit Innenkonus
Erkek Diş Adaptörü İç Konik

Material: Ms58 Brass
Messing - Pirinç



- | | | |
|---------------|---------|---------|
| MMN10-10 | BSP 1/8 | BSP 1/8 |
| MMN13-13 | BSP 1/4 | BSP 1/4 |
| MMN 17-17 | BSP 3/8 | BSP 3/8 |
| MMN 21-21 | BSP 1/2 | BSP 1/2 |
| MMN 26-26 | BSP 3/4 | BSP 3/4 |
| MMN 13-1415 | BSP 1/4 | M14x1.5 |
| MMN 17-1615 | BSP 3/8 | M16x1.5 |
| MMN 21-1815 | BSP 1/2 | M18x1.5 |
| MMN 26-2415 | BSP 3/4 | M24x1.5 |
| MMN 1415-1415 | M14x1.5 | M14x1.5 |
| MMN 1615-1615 | M16x1.5 | M16x1.5 |

45° & 90° Male to Female Elbow
Innen - Aussengewinde Winkel
İç - Diş Dişli Dirsek

Material: Ms58 Brass - Messing - Pirinç

- | | |
|--------------|---------|
| EBFM 10 - 90 | BSP 1/8 |
| EBFM 13 - 90 | BSP 1/4 |
| EBFM 17 - 90 | BSP 3/8 |
| EBFM 21 - 90 | BSP 1/2 |
| EBFM 26 - 90 | BSP 3/4 |
| EBFM 33 - 90 | BSP 1 |
| EBFM 10 - 45 | BSP 1/8 |
| EBFM 13 - 45 | BSP 1/4 |
| EBFM 17 - 45 | BSP 3/8 |
| EBFM 21 - 45 | BSP 1/2 |
| EBFM 26 - 45 | BSP 3/4 |
| EBFM 33 - 45 | BSP 1 |



ACCESSORIES

rtc TYPE SPN

Swivel PushLock Hose Nippel



Material: Steel - Stahl
Plate: Zinc

- | | | |
|-------------|---------|------------|
| SPN 1215-06 | M12x1.5 | 1/4 - 6.3 |
| SPN 1415-06 | M14x1.5 | 1/4 - 6.3 |
| SPN 1615-10 | M16x1.5 | 3/8 - 9.5 |
| SPN 1815-10 | M18x1.5 | 3/8 - 9.5 |
| SPN 2215-13 | M22x1.5 | 1/2 - 12.7 |
| SPN 2615-16 | M26x1.5 | 5/8 - 15.9 |
| SPN 3020-19 | M30x2.0 | 3/4 - 19.1 |
| SPN 3620-25 | M36x2.0 | 1 - 25.4 |



Material: Steel - Stahl
Plate: Zinc

- | | | |
|----------------|---------|------------|
| SPN 1215-06-45 | M12x1.5 | 1/4 - 6.3 |
| SPN 1415-06-45 | M14x1.5 | 1/4 - 6.3 |
| SPN 1615-10-45 | M16x1.5 | 3/8 - 9.5 |
| SPN 1815-10-45 | M18x1.5 | 3/8 - 9.5 |
| SPN 2215-13-45 | M22x1.5 | 1/2 - 12.7 |
| SPN 2615-16-45 | M26x1.5 | 5/8 - 15.9 |
| SPN 3020-19-45 | M30x2.0 | 3/4 - 19.1 |
| SPN 3620-25-45 | M36x2.0 | 1 - 25.4 |



Material: Steel - Stahl
Plate: Zinc

- | | | |
|----------------|---------|------------|
| SPN 1215-06-90 | M12x1.5 | 1/4 - 6.3 |
| SPN 1415-06-90 | M14x1.5 | 1/4 - 6.3 |
| SPN 1615-10-90 | M16x1.5 | 3/8 - 9.5 |
| SPN 1815-10-90 | M18x1.5 | 3/8 - 9.5 |
| SPN 2215-13-90 | M22x1.5 | 1/2 - 12.7 |
| SPN 2615-16-90 | M26x1.5 | 5/8 - 15.9 |
| SPN 3020-19-90 | M30x2.0 | 3/4 - 19.1 |
| SPN 3620-25-90 | M36x2.0 | 1 - 25.4 |

ACCESSORIES

TYPE MHN & FHN & HHN **rtc**

Male and Female Hose Nipples with 8 Different Hose-Connection Types
8 Schlauchanschlusstypen mit Innen- und Aussengewinde
8 Farklı hortum bağlantı profilili Erkek ve Dişi Vidalı uçlar

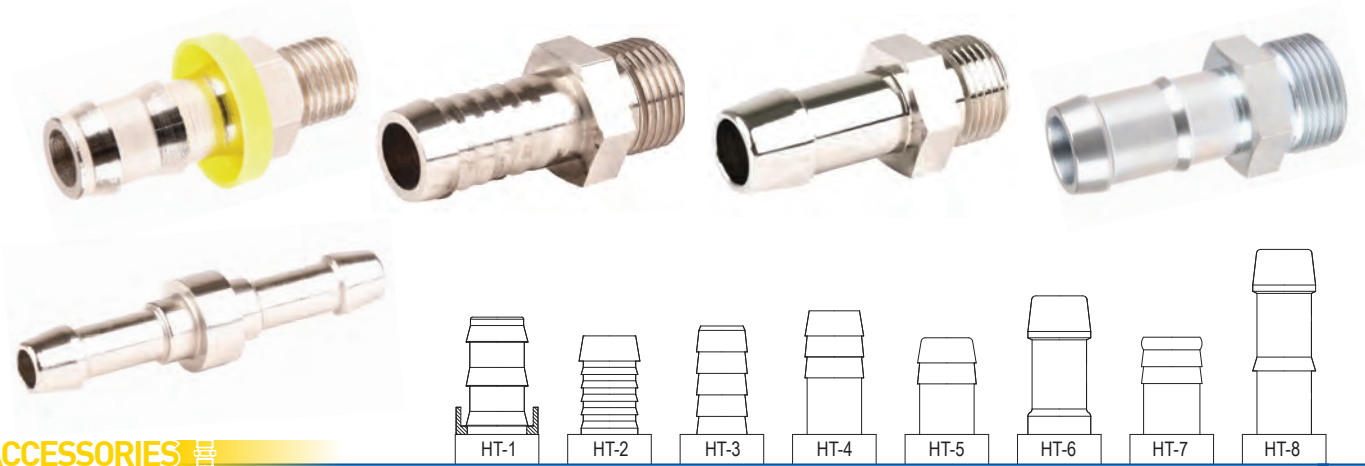

ACCESSORIES **rtc**

rtc TYPE 117 & 118

rtc type 117
Brass Collector
Messing Verteiler
Pirinç Kollektör

Inlet / Einlass
3/4"
1"
1-1/4"

Outlet / Auslass
1/4" & 3/8"
1/4" & 3/8" & 1/2"
3/8" & 1/2" & 3/4"

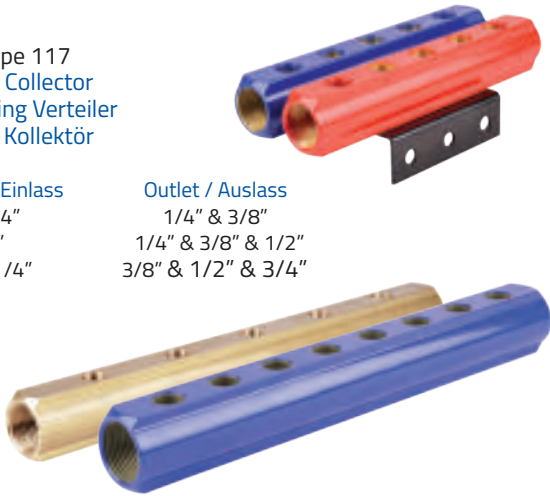

rtc type 118
5 Surfaced Aluminium Collector
5 Seitiger Aluminium Verteiler
5 Yüzlü Alüminyum Kollektör

Inlet / Einlass
3/4"
1"
1-1/4"
1-1/2"
2"

Outlet / Auslauf
1/4" & 3/8"
1/4" & 3/8"
1/4" & 3/8" & 1/2"
3/8" & 1/2"
3/8" & 1/2" & 3/4"



TYPE 119 **rtc**

rtc type 119
3 Surfaced Stainless Steel Collector
3 Seitiger Edelstahl Verteiler
3 Yüzlü Paslanmaz Çelik Kollektör

Inlet / Einlass
1"
1-1/4"
1-1/2"

Outlet / Auslauf
1/4" & 3/8" & 1/2"
1/4" & 3/8" & 1/2"
1/4" & 3/8" & 1/2"



Options

Low port thread is shown on the picture.

- High port thread,
- Twin profile, (max. 2 Surfaced hole is available)
- Divided profile are available.

rtc TYPE Ball Valves Male - Female

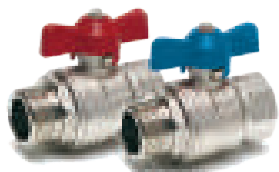

T Handle Ball Valve

Order No / Bestellnr.		Connection Anschluss
Red / Rot	Blue/ Blau	
TVFM 13-R	TVFM 13-B	BSP 1/4
TVFM 17-R	TVFM 17-B	BSP 3/8
TVFM 21-R	TVFM 21-B	BSP 1/2
TVFM 26-R	TVFM 26-B	BSP 3/4
TVFM 33-R	TVFM 33-B	BSP 1
TVFM 42-R	TVFM 42-B	BSP 1-1/4



Standard Ball Valve

Order No / Bestellnr.		Connection Anschluss
Red / Rot	Blue/ Blau	
SVFM 13-R	SVFM 13-B	BSP 1/4
SVFM 17-R	SVFM 17-B	BSP 3/8
SVFM 21-R	SVFM 21-B	BSP 1/2
SVFM 26-R	SVFM 26-B	BSP 3/4
SVFM 33-R	SVFM 33-B	BSP 1
SVFM 42-R	SVFM 42-B	BSP 1-1/4
SVFM 48-R	SVFM 48-B	BSP 1-1/2



Mini Ball Valve

Order No / Bestellnr.		Connection Anschluss
Red / Rot	Blue/ Blau	
KVFM 13-R	KVFM 13-B	BSP 1/4
KVFM 17-R	KVFM 17-B	BSP 3/8
KVFM 21-R	KVFM 21-B	BSP 1/2
KVFM 26-R	KVFM 26-B	BSP 3/4

ACCESSORIES

TYPE Ball Valves Female - Female **rtc**



T Handle Ball Valve

Order No / Bestellnr.		Connection Anschluss
Red / Rot	Blue/ Blau	
TVFF 13-R	TVFF 13-B	BSP 1/4
TVFF 17-R	TVFF 17-B	BSP 3/8
TVFF 21-R	TVFF 21-B	BSP 1/2
TVFF 26-R	TVFF 26-B	BSP 3/4
TVFF 33-R	TVFF 33-B	BSP 1
TVFF 42-R	TVFF 42-B	BSP 1-1/4



Standard Ball Valve

Order No / Bestellnr.		Connection Anschluss
Red / Rot	Blue/ Blau	
SVFF 13-R	SVFF 13-B	BSP 1/4
SVFF 17-R	SVFF 17-B	BSP 3/8
SVFF 21-R	SVFF 21-B	BSP 1/2
SVFF 26-R	SVFF 26-B	BSP 3/4
SVFF 33-R	SVFF 33-B	BSP 1
SVFF 42-R	SVFF 42-B	BSP 1-1/4
SVFF 48-R	SVFF 48-B	BSP 1-1/2



Mini Ball Valve

Order No / Bestellnr.		Connection Anschluss
Red / Rot	Blue/ Blau	
KVFF 13-R	KVFF 13-B	BSP 1/4
KVFF 17-R	KVFF 17-B	BSP 3/8
KVFF 21-R	KVFF 21-B	BSP 1/2
KVFF 26-R	KVFF 26-B	BSP 3/4

ACCESSORIES

rtc TYPE LOCK HOSE



Push To Connect (rtc LOCK) Type Hose

Tube: Hydraulic oil and water resistant special synthetic rubber

Reinforcement: High textile synthetic textile braid

Cover: Oil, abrasion, ozone and water resistant special synthetic rubber

Application: For hydraulic control lines, discharge under low pressure of hydraulic fluids, fuel oil, grease, air and water

Medium Temperature: Air 70°C - Water 90°C
Max. Bursting Pressure: 200 bar
Max. Working Pressure: 28 bar
Colors: Red, Blue, Black
Dimensions: 3/8 - 1/2 - 5/8 - 3/4

Temperature: rtc LOCK 90	-40°C +90°C (-40°F +194°F)
rtc LOCK S-90	-40°C +90°C (-40°F +194°F)
rtc LOCK S-140	-40°C +140°C (-40°F +284°F)



ACCESSORIES

New Design

TYPE M090 **rtc**

EUROPEAN Type - EUROPÄISCHER Typ - AVRUPA Tip

Temperature Range - Temperaturbereich - Sıcaklık Aralığı
-20°C +100°C (-4°F +212°F) Nitril (N)
-10°C +180°C (+14°F +356°F) FPM (V)

Max.Working Pressure - Max. Betriebsdruck - Max. Çalışma basıncı
16 bar (232 PSI)

Flow size - Nennweiten - Akış Çapı
rtc M090.06* 6 mm
rtc M090.09* 9 mm
rtc M090.13* 13 mm

Connections - Anschlüsse - Bağlantı
6 / 8 / 10 / 12 / 16 / 20 / 24

Circuits - Kreislauf - Giriş/Çıkış
3 ↔ 3 | 4 ↔ 4 | 5 ↔ 5 | 6 ↔ 6 | 8 ↔ 8 | 10 ↔ 10 | 12 ↔ 12



WATER
PNEUMATIC

*New Design - Neues Design - Yeni Tasarım

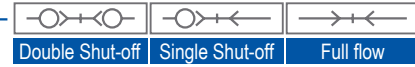

rtc TYPE M099

New Design



INTERNATIONAL Type - INTERNATIONAL Typ - ULUSLARARASI Tip

Temperature Range - Temperaturbereich - Sıcaklık Aralığı
-20°C +100°C (-4°F +212°F) Nitril (N)
-10°C +180°C (+14°F +356°F) FPM (V)

Max.Working Pressure - Max. Betriebsdruck - Max. Çalışma basıncı
16 bar (232 PSI)

Flow size - Nennweiten - Akış Çapı
rtc M099.06* 6 mm
rtc M099.09* 9 mm

Connections - Anschlüsse - Bağlantı
6 / 8 / 10 / 12 / 16 / 20 / 24

Circuits - Kreislauf - Giriş/Çıkış
3 ↔ 3 | 4 ↔ 4 | 5 ↔ 5 | 6 ↔ 6 | 8 ↔ 8 | 10 ↔ 10 | 12 ↔ 12

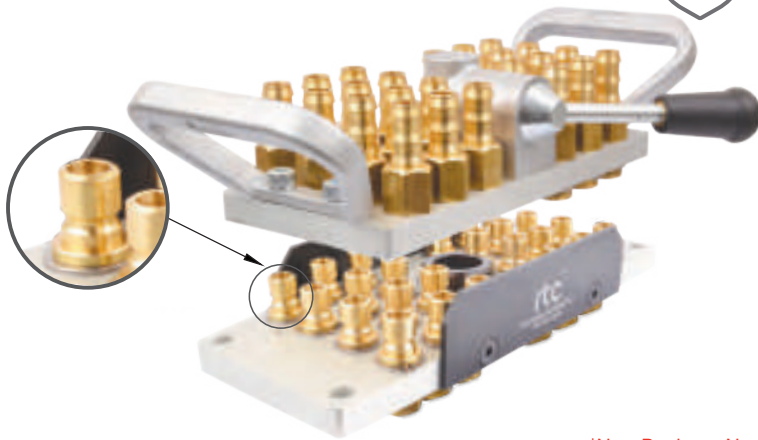

*New Design - Neues Design - Yeni Tasarım



WATER
PNEUMATIC

Temperature Range - Temperaturbereich - Sıcaklık Aralığı
-20°C +100°C (-4°F +212°F) Nitril (N)
-10°C +180°C (+14°F +356°F) FPM (V)

Max.Working Pressure - Max. Betriebsdruck - Max. Çalışma basıncı
16 bar (232 PSI)

Flow size - Nennweiten - Akış Çapı
rtc M101.06 6 mm
rtc M101.09 9 mm
rtc M101.10* 10 mm
rtc M101.12 12 mm
rtc M101.16 16 mm

Connections - Anschlüsse - Bağlantı
6 / 8 / 10 / 12 / 16 / 20 / 24

Circuits - Kreislauf - Giriş/Çıkış
3 ↔ 3 | 4 ↔ 4 | 5 ↔ 5 | 6 ↔ 6 | 8 ↔ 8 | 10 ↔ 10 | 12 ↔ 12

TYPE M101 **rtc**

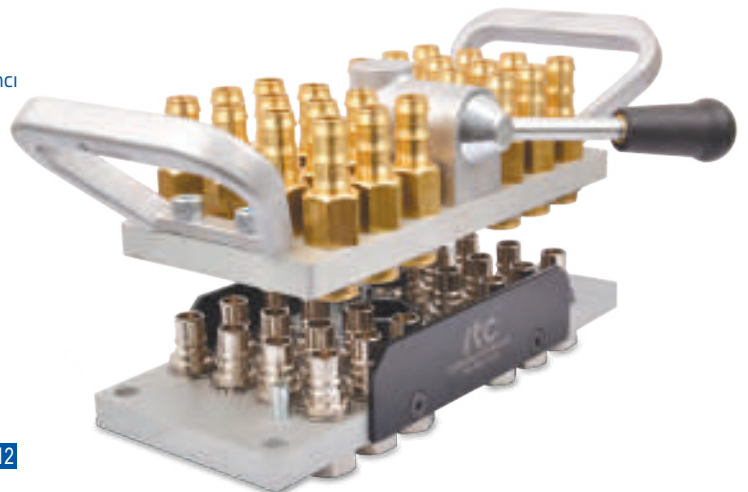

WATER
PNEUMATIC

*New Design - Neues Design - Yeni Tasarım

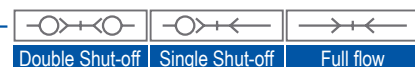

rtc TYPE M150



Flat Faced Non-Spill Multi-Couplings
Flachdichtende Multikupplung in Lecksgefreier Ausführung
Düz Alınlı Damlatmasız Manifold

Temperature Range - Temperaturbereich - Sıcaklık Aralığı
-10°C +180°C (+14°F +356°F) FPM (V)

Max.Working Pressure - Max. Betriebsdruck - Max. Çalışma basıncı
16 bar (232 PSI)

Flow size - Nennweiten - Akış Çapı
rtc M150.09 9 mm
rtc M150.12 12 mm

Connections - Anschlüsse - Bağlantı
6 / 12 / 18

Circuits - Kreislauf - Giriş/Çıkış
3 ↔ 3 | 6 ↔ 6 | 9 ↔ 9



Flat Faced Non-Spill Multi-Couplings
Flachdichtende Multikupplung in Lecksgefreier Ausführung
Düz Alınlı Damlatmasız Manifold

Temperature Range - Temperaturbereich - Sıcaklık Aralığı
-10°C +180°C (+14°F +356°F) FPM (V)

Max.Working Pressure - Max. Betriebsdruck - Max. Çalışma basıncı
16 bar (232 PSI)

Flow size - Nennweiten - Akış Çapı
rtc M152.06 6 mm
rtc M152.10 10 mm
rtc M152.12 12 mm
rtc M152.16 16 mm

Connections - Anschlüsse - Bağlantı
6 / 8 / 10 / 12 / 16 / 20 / 24

Circuits - Kreislauf - Giriş/Çıkış
3 ↔ 3 | 4 ↔ 4 | 5 ↔ 5 | 6 ↔ 6 | 8 ↔ 8 | 10 ↔ 10 | 12 ↔ 12

*New Design - Neues Design - Yeni Tasarım

New Design

TYPE M152 **rtc**



WATER

rtc TYPE M153

Flat Faced Non-Spill Multi-Couplings
Flachdichtende Multikupplung in Lecksgefreier Ausführung
Düz Alınlı Damlatmasız Manifold

Temperature Range - Temperaturbereich - Sıcaklık Aralığı
-10°C +180°C (+14°F +356°F) FPM (V)

Max.Working Pressure - Max. Betriebsdruck - Max. Çalışma basıncı
16 bar (232 PSI)

Flow size - Nennweiten - Akış Çapı
rtc M153.09 9 mm

Connections - Anschlüsse - Bağlantı
6 / 12 / 18

Circuits - Kreislauf - Giriş/Çıkış
3 ↔ 3 | 6 ↔ 6 | 9 ↔ 9



WATER

Residual Pressure Connection

Flat Faced Non-Spill Multi-Couplings
Flachdichtende Multikupplung in Lecksgefreier Ausführung
Düz Alınlı Damlatmasız Manifold

Temperature Range - Temperaturbereich - Sıcaklık Aralığı
-20°C +100°C (-4°F +212°F) Nitril (N)
-10°C +180°C (+14°F +356°F) FPM (V)

Max.Working Pressure - Max. Betriebsdruck - Max. Çalışma basıncı
rtc M103.10 200 bar (2900 PSI)

Flow size - Nennweiten - Akış Çapı
rtc M103.10 10 mm

Connections - Anschlüsse - Bağlantı
2 / 4 / 6 / 8

Circuits - Kreislauf - Giriş/Çıkış
1 ↔ 1 2 ↔ 2 3 ↔ 3 4 ↔ 4

New Design

TYPE M103 **rtc**

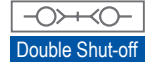

HYDRAULIC

rtc TYPE M104



Flat Faced Non-Spill Multi-Couplings
Flachdichtende Multikupplung in Lecksgefreier Ausführung
Düz Alınlı Damlatmasız Manifold

Temperature Range - Temperaturbereich - Sıcaklık Aralığı
-20°C +100°C (-4°F +212°F) Nitril (N)
-10°C +180°C (+14°F +356°F) FPM (V)

Max.Working Pressure - Max. Betriebsdruck - Max. Çalışma basıncı
rtc M104.08 200 bar (2900 PSI)

Flow size - Nennweiten - Akış Çapı
rtc M104.08 8 mm
rtc M104.10 10 mm

Connections - Anschlüsse - Bağlantı
2 / 4 / 6 / 8

Circuits - Kreislauf - Giriş/Çıkış
1 ↔ 1 2 ↔ 2 3 ↔ 3 4 ↔ 4



HYDRAULIC

Flat Faced Non-Spill Multi-Couplings
Flachdichtende Multikupplung in Lecksgefreier Ausführung
Düz Alınlı Damlatmasız Manifold

Temperature Range - Temperaturbereich - Sıcaklık Aralığı
-20°C +100°C (-4°F +212°F) Nitril (N)
-10°C +180°C (+14°F +356°F) FPM (V)

Max.Working Pressure - Max. Betriebsdruck - Max. Çalışma basıncı
rtc M115.03 100 bar (1450 PSI)

Flow size - Nennweiten - Akış Çapı
rtc M115.03 3 mm
rtc M115.05 5 mm

Connections - Anschlüsse - Bağlantı
2 / 4 / 6 / 8 / 10 / 12 / 14 / 16

Circuits - Kreislauf - Giriş/Çıkış
1 ↔ 1 2 ↔ 2 3 ↔ 3 4 ↔ 4 5 ↔ 5 6 ↔ 6 7 ↔ 7 8 ↔ 8



TYPE M115 **rtc**

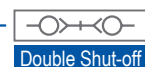

HYDRAULIC

rtc TYPE M301 - Mini-Con



Customised Mini-Connector
MiniSondermultikupplungen
Özel Tasarım Mini Manifold

Pneumatic connector is efficient and easy to operate.

Main advantage of the connector is, it can be able to fix up to 16 different pneumatic tubing and takes no effort.

Because of its compact design Mini-Con takes a minimum space.

Mainly using areas; robot control systems, machinery, compressed air.



Electrical Connectors

Insulator Types - Isolator Typ - Yalıtkan Tipleri

rtc type EC.02	Ø 25.4 mm
rtc type EC.03	Ø 40 mm
rtc type EC.04	Ø 58.5 mm

Temperature Range - Temperaturbereich - Sıcaklık Aralığı

-30°C +100°C (-22°F +212°F)	Nitril (N)
-40°C +150°C (-40°F +302°F)	Silicone (Si)
-40°C +100°C (-40°F +212°F)	Chloroprene (Cp)

Working Current Range (A)

Ø 1.5	2 - 24 A
Ø 2	12 - 24 A
Ø 3	34 - 45 A
Ø 5	60 - 80 A
Ø 6	80 - 110 A
Ø 8	150 - 200 A
Ø 11	200 - 260 A

Voltage Range (V)

25 - 250 V
25 - 250 V
250 - 440 V
250 - 630 V
250 - 630 V
250 - 630 V
250 - 830 V

Electrical Connectors

TYPE EC **rtc**



ELECTRICAL

rtc TYPE Customised Multi Coupling System

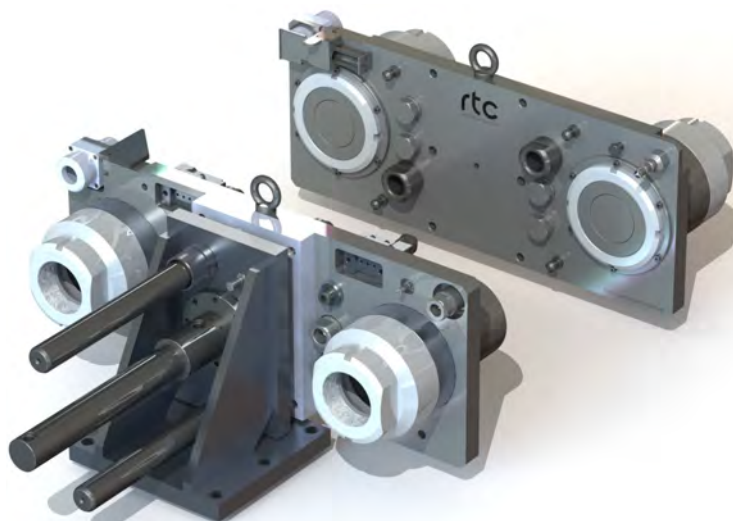

Customised Multi-Couplings
Sondermultikupplungen nach Kundenwunsch
Özel Tasarım Manifold

Customised Multi-Couplings are specially designed according to the customer's needs.

All kinds of connections, such as, **Water**, **Pneumatic**, **Hydraulic** and **Electrical Connectors** can be mounted on the same plate, in order to minimise the mold changing time without any possible mistake.

Our Research & Development team provides the best solution to the end users, according to the specific inquiries.



GLOBAL PRESENCE – INTELLIGENT SOLUTIONS! MEET US ALL OVER THE WORLD

RTC TEC Bağlantı Elemanları AŞ (Headquarters)

IDOSB, Kadife Caddesi, No:2 PK:34956
Aydınlı / Tuzla / İstanbul / TÜRKİYE
Tel: +90 216 593 47 82 - Fax:+90 216 593 47 85
sales@rtc-tec.com

RTC TEC Germany GmbH

Daimlerstraße 10. 73037 Göppingen
Te.: +49 7161 98796-50
Fax: +49 7161 98779
mail@rtc-couplings.com

 RTC Austria

austria@rtc-tec.com

   RTC BeNeLux

benelux@rtc-tec.com

 RTC Czech Republic

czechrepublic@rtc-tec.com

 RTC France

france@rtc-tec.com

 RTC Germany

germany@rtc-tec.com

 RTC Hungary

hungary@rtc-tec.com

 RTC Italy

italy@rtc-tec.com

 RTC Poland

poland@rtc-tec.com

 RTC Portugal

portugal@rtc-tec.com

 RTC Slovakia

slovakia@rtc-tec.com

 RTC Spain

spain@rtc-tec.com

 RTC UK

uk@rtc-tec.com

 RTC Israel

israel@rtc-tec.com

 RTC USA

usa@rtc-tec.com

 RTC Canada

canada@rtc-tec.com

 RTC Mexico

mexico@rtc-tec.com

 RTC Brazil

brazil@rtc-tec.com

 RTC Australia

australia@rtc-tec.com

 RTC China

china@rtc-tec.com

 RTC Japan

japan@rtc-tec.com

 RTC India

india@rtc-tec.com

 RTC New Zealand

newzealand@rtc-tec.com

 RTC South Korea

southkorea@rtc-tec.com

 RTC Thailand

thailand@rtc-tec.com

 RTC Morocco

morocco@rtc-tec.com

 RTC South Africa

southafrica@rtc-tec.com



www.rtc-tec.com
www.rtc-couplings.com

